

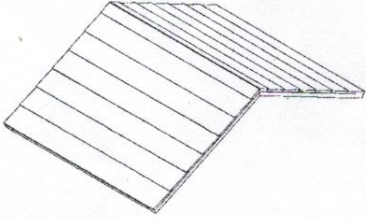

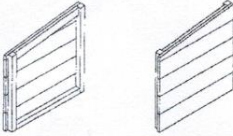

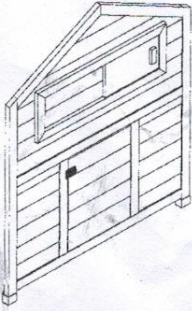

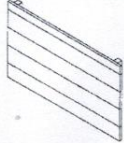
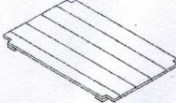
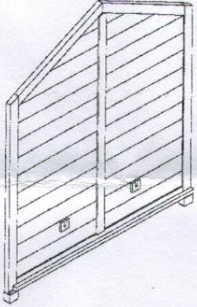
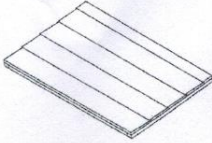
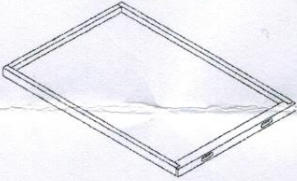
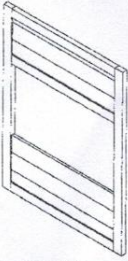

		7		2ks	
		8		2ks	
1		1ks	9		1ks
			10		1ks
2		1ks	11		1ks
			12		1ks
3		1ks	A	 3.0*10	4ks
			B	 3.0*16	6ks
4		1ks	C	 3.0*20	4ks
			D	 3.5*25	4ks
5		2ks	E	 3.5*30	8ks
			F	 3.5*40	12ks
6		1ks	G	 M45*φ6	4ks
			H		1ks

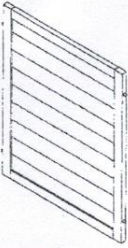
1



2

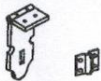
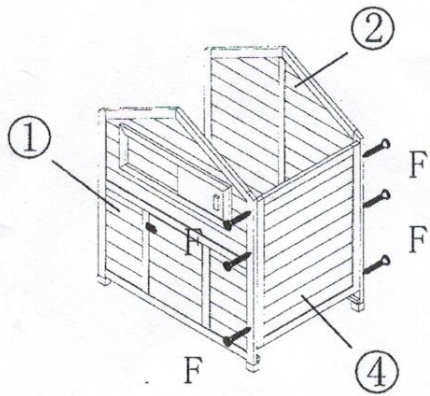
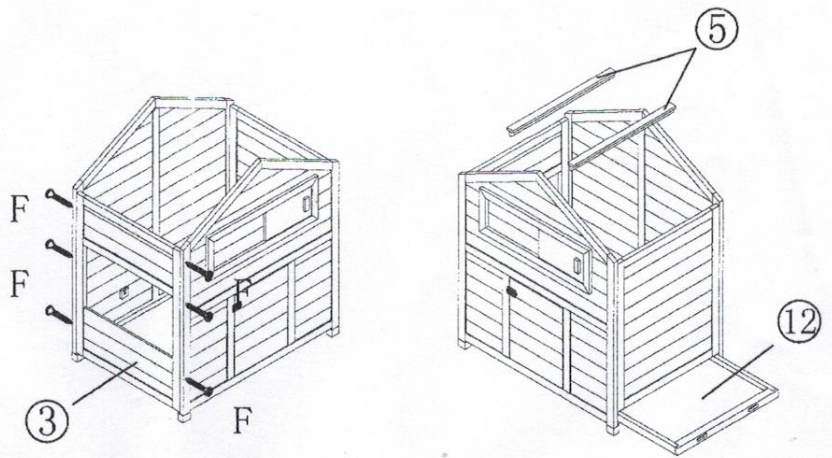

3

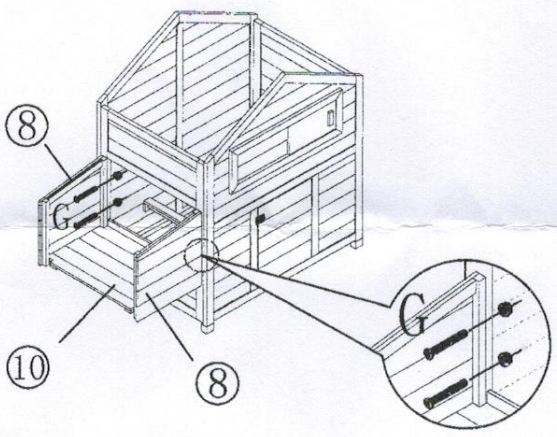

4

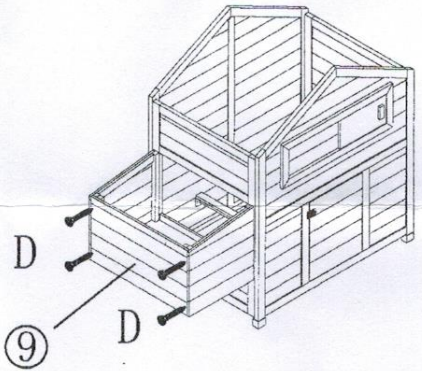

5

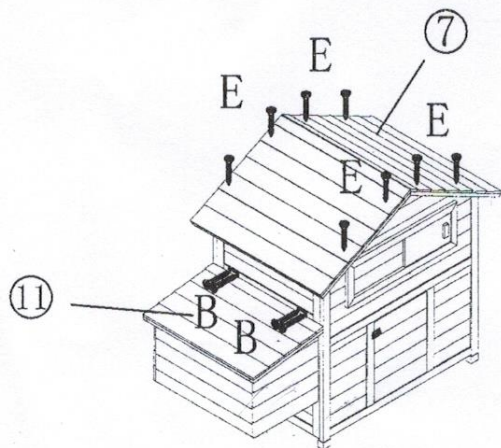

6

